

<p>Prøve</p> 	<p>40 Skud</p> 	
<p>1: 10.0 ↗ 2: 9.6 ↓ 3: 10.1 ↗ 4: 9.5 → 5: 10.0 ↗ 6: 9.7 → 7: 9.3 ↓ 8: 9.9 ↓</p>	<p>1: 9.5 ↖ 2: 10.1 ↘ 3: 9.6 ↗ 4: 8.7 ↖ 5: 9.1 → 6: 8.3 ↓ 7: 9.7 ↑ 8: 10.0 → 9: 9.9 ← 10: 10.1 →</p>	
Serie 75.0	Serie 91.0	
Total 0.0	Total 91.0	
<p>40 Skud</p> 	<p>40 Skud</p> 	
<p>11: 9.9 → 12: 9.6 ↗ 13: 9.5 ↓ 14: 9.6 → 15: 8.8 ↖ 16: 9.5 ↓ 17: 9.8 ↗ 18: 9.7 ↓ 19: 9.1 ↖ 20: *10.4 ↘</p>	<p>21: 10.1 ↓ 22: 9.5 → 23: 9.5 ↗ 24: 9.9 ↗ 25: 9.2 ↓ 26: 9.4 ↓ 27: 9.2 ↖ 28: 9.7 ↗ 29: 9.7 ↗ 30: 9.0 →</p>	
Serie 90.0	Serie 91.0	
Total 181.0	Total 272.0	
<p>40 Skud</p> 		
<p>31: 9.3 ↗ 32: 10.3 → 33: 9.4 ↘ 34: *10.4 → 35: 10.0 → 36: 9.7 ↓ 37: 8.9 ↖ 38: 9.3 → 39: *10.4 ↘ 40: 9.3 ↖</p>		
Serie 93.0		
Total 365.0		

<p>Prøve</p> 	<p>1: 9.5 →</p> <p>2: 10.3 ↖</p> <p>3: 10.1 ↗</p> <p>4: 9.7 ↗</p> <p>5: 10.0 ↖</p> <p>6: *10.4 ↖</p> <p>7: 9.4 ↗</p> <p>8: 9.7 ↘</p> <p>9: 9.9 ↖</p> <p>10: *10.6 ↖</p> <hr/> <p>Serie 95.0</p> <p>Total 0.0</p>	<p>Prøve</p> 	<p>11: 9.8 ↖</p> <p>12: 9.0 ↗</p> <p>13: 9.1 ↘</p> <p>14: 9.2 ↗</p> <p>15: 9.6 ↘</p> <p>16: 9.3 ↗</p> <p>17: 9.6 ↖</p> <p>18: 10.1 ↘</p> <p>19: *10.5 ↗</p> <p>20: 9.6 ↗</p> <hr/> <p>Serie 92.0</p> <p>Total 0.0</p>
<p>40 Skud</p> 	<p>1: 10.0 ↖</p> <p>2: 10.0 ↗</p> <p>3: 10.3 ↗</p> <p>4: 8.4 ↗</p> <p>5: *10.7 ↘</p> <p>6: 9.4 ↘</p> <p>7: *10.5 ↘</p> <p>8: 9.1 ↘</p> <p>9: 9.2 ↘</p> <p>10: 10.2 ↖</p> <hr/> <p>Serie 95.0</p> <p>Total 95.0</p>	<p>40 Skud</p> 	<p>11: 10.0 ↘</p> <p>12: 10.2 ↖</p> <p>13: *10.6 ↗</p> <p>14: 9.7 ↘</p> <p>15: *10.7 ↗</p> <p>16: *10.5 ↖</p> <p>17: 9.2 ↖</p> <p>18: 8.7 ↗</p> <p>19: 9.1 ↘</p> <p>20: 9.7 ↘</p> <hr/> <p>Serie 94.0</p> <p>Total 189.0</p>
<p>40 Skud</p> 	<p>21: *10.7 ↗</p> <p>22: 10.2 ↗</p> <p>23: 10.0 ↗</p> <p>24: *10.5 ↖</p> <p>25: *10.8 ↘</p> <p>26: 9.7 ↗</p> <p>27: 8.7 ↗</p> <p>28: 10.3 ↘</p> <p>29: 9.4 ↘</p> <p>30: 9.8 →</p> <hr/> <p>Serie 95.0</p> <p>Total 284.0</p>	<p>40 Skud</p> 	<p>31: 9.2 ↖</p> <p>32: 9.7 ↘</p> <p>33: 10.1 ↘</p> <p>34: 9.1 ↘</p> <p>35: 9.8 ↗</p> <p>36: *10.4 ↘</p> <p>37: 10.0 ↖</p> <p>38: *10.8 ↘</p> <p>39: 9.5 ↘</p> <p>40: 9.2 ↗</p> <hr/> <p>Serie 94.0</p> <p>Total 378.0</p>

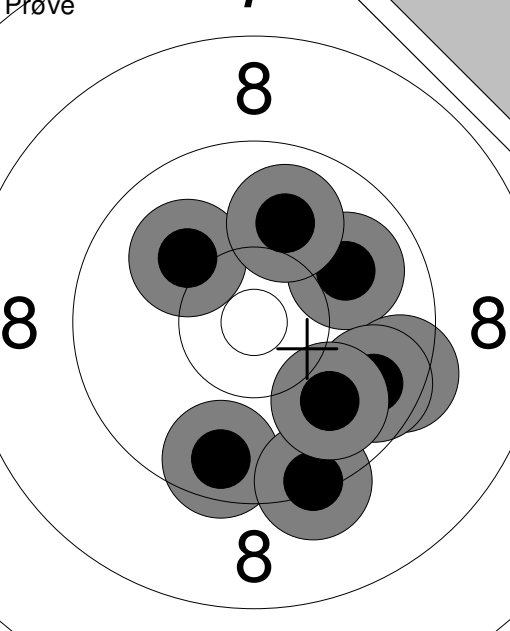

1:	9.9	↘
2:	9.4	→
3:	9.4	↘
4:	9.9	↓
5:	8.4	→
6:	*10.2	↓
7:	*10.5	←
8:	9.6	↗
9:	*10.3	↗
10:	9.7	→
Serie		92.0
Total		0.0

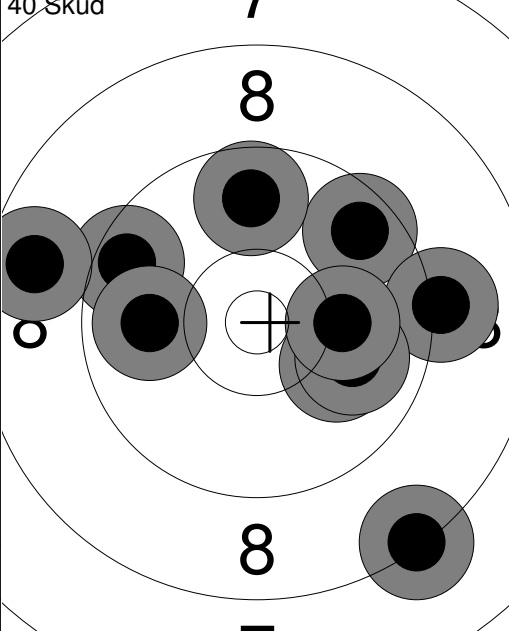
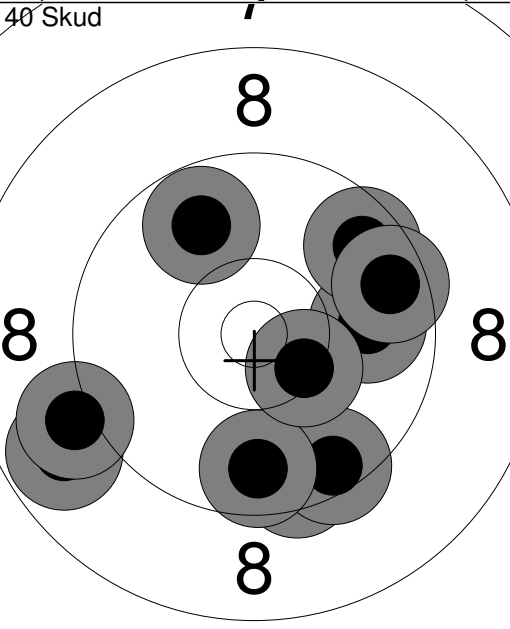
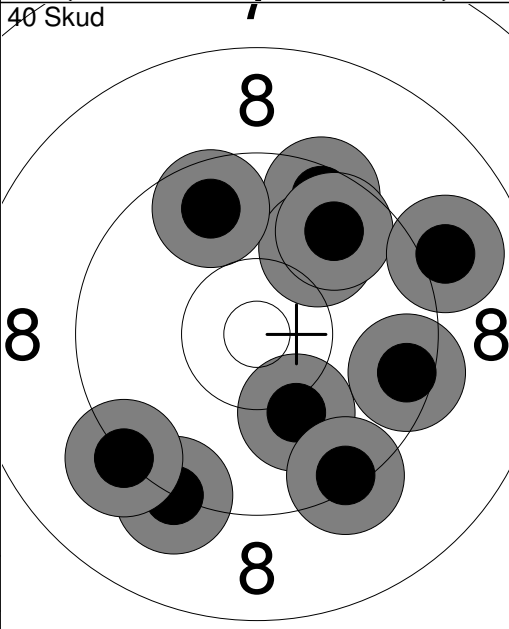
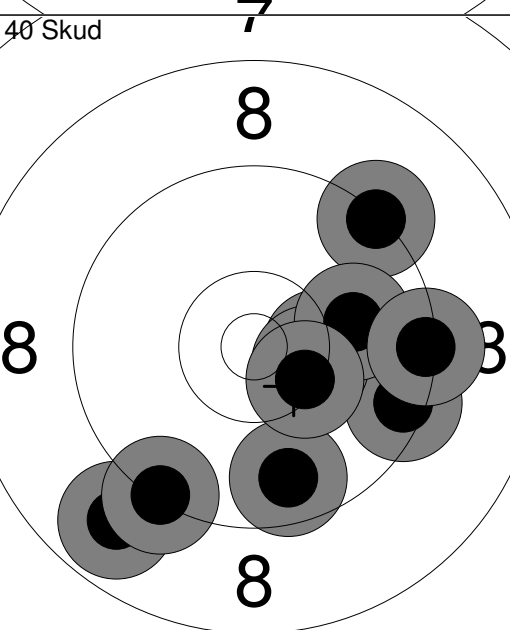
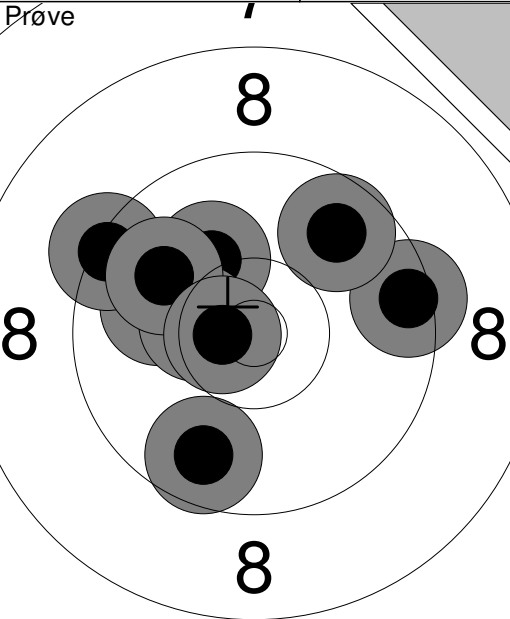
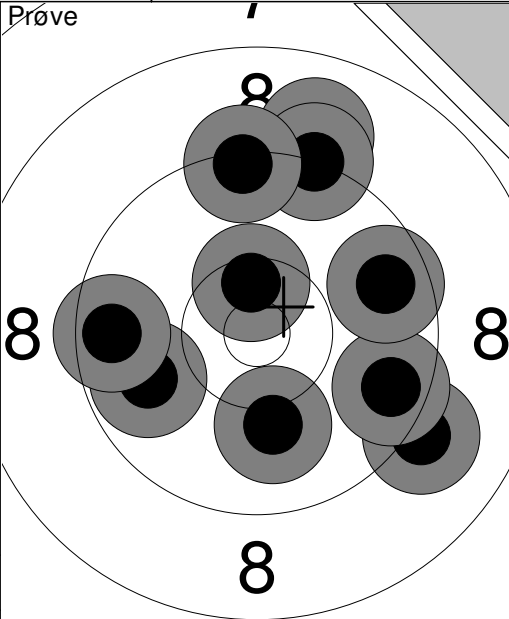
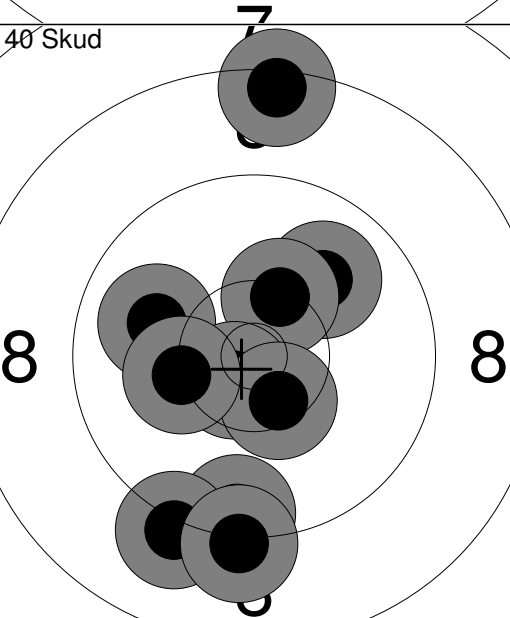
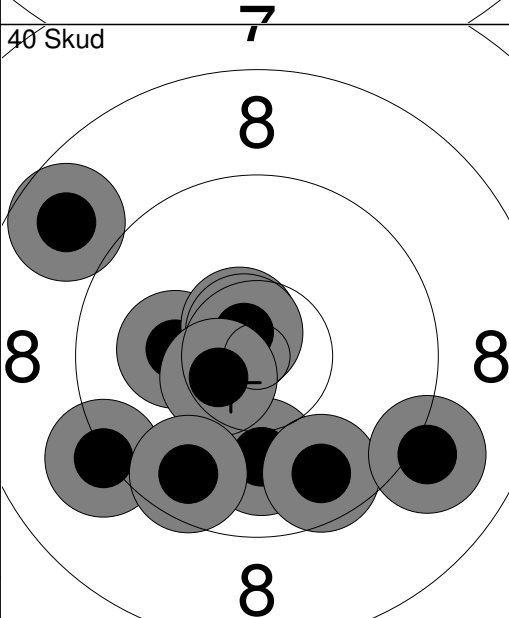
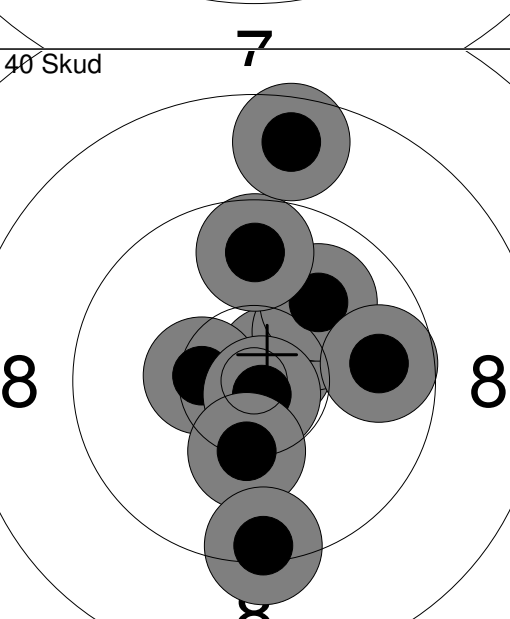
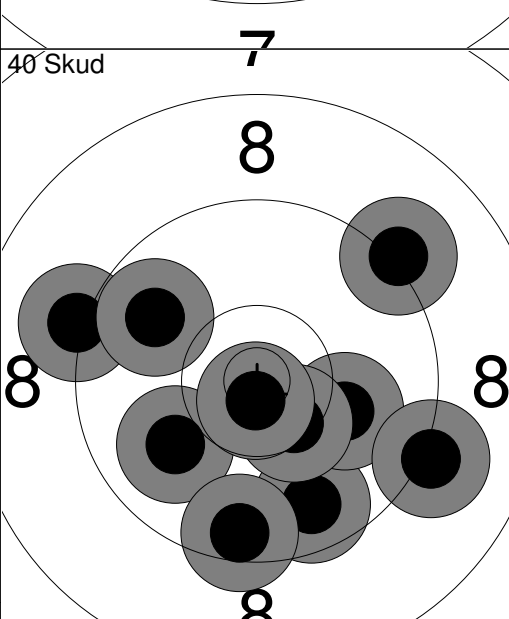
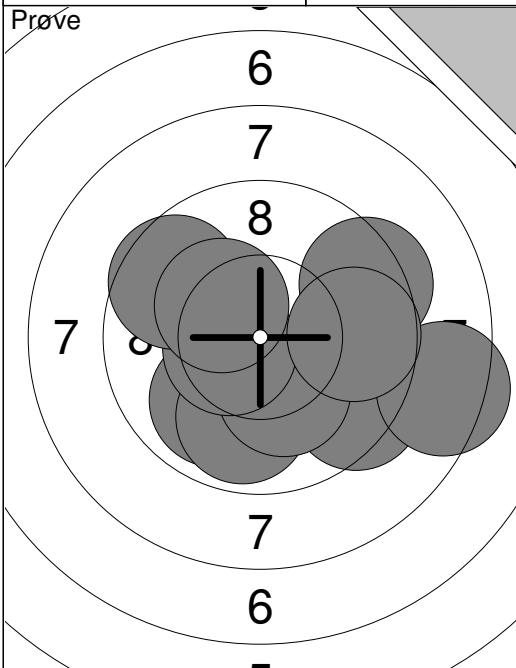
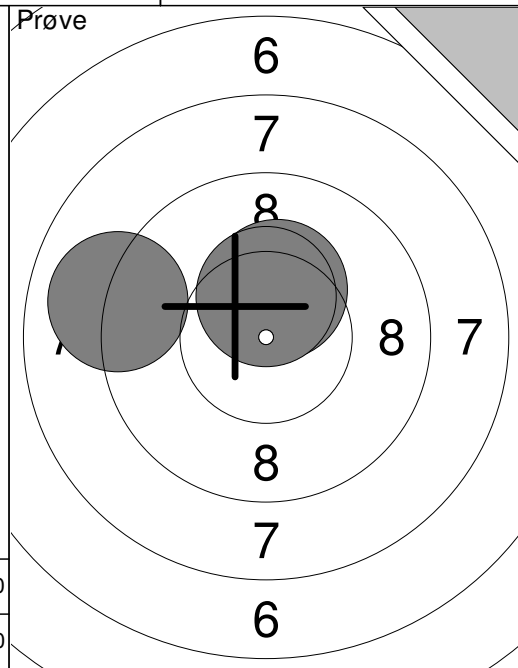

11:	*10.3	↗
12:	9.0	←
13:	*10.4	↗
Serie		29.0
Total		0.0

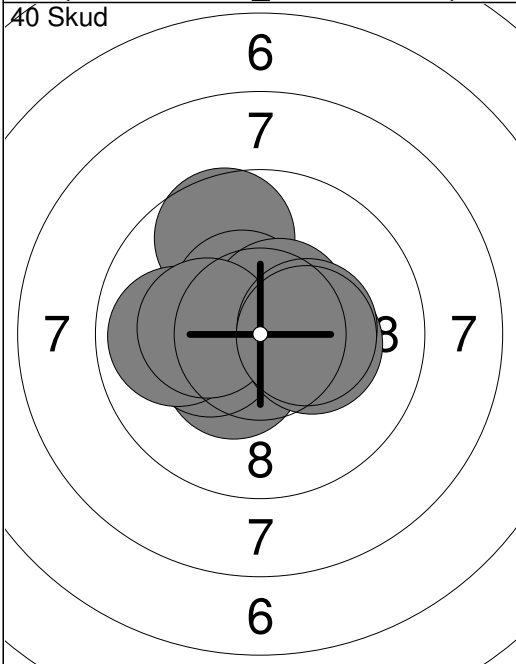

1:	9.6	↗
2:	*10.4	↘
3:	*10.3	←
4:	9.9	←
5:	*10.5	↗
6:	*10.5	↗
7:	*10.3	→
8:	*10.3	←
9:	*10.4	→
10:	*10.4	→
Serie		98.0
Total		98.0

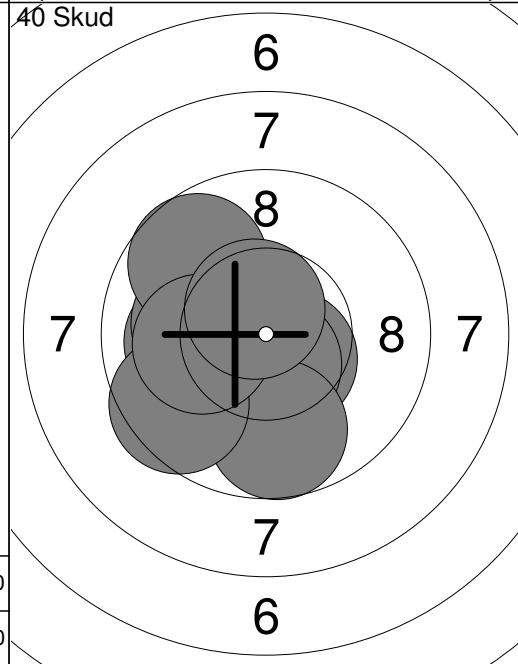

11:	*10.5	↘
12:	10.0	←
13:	10.1	←
14:	*10.5	←
15:	9.7	↗
16:	*10.6	↓
17:	9.7	↓
18:	9.5	↙
19:	10.1	←
20:	*10.6	↗
Serie		97.0
Total		195.0

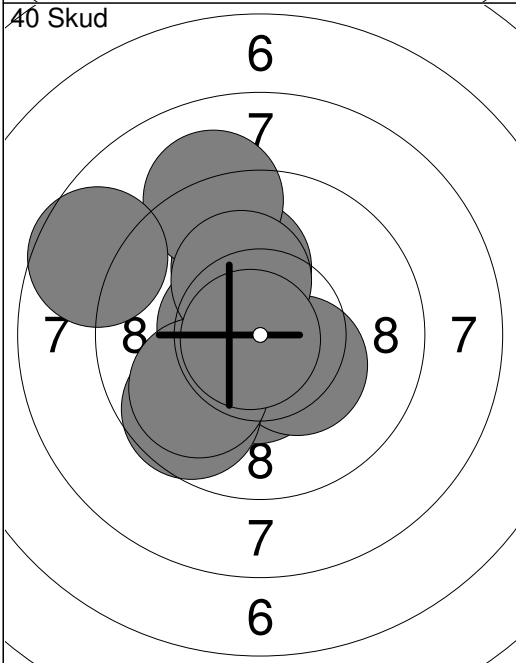

21:	*10.5	↓
22:	*10.3	↘
23:	9.7	↘
24:	*10.5	←
25:	10.1	↗
26:	9.1	↗
27:	9.9	↙
28:	8.7	↙
29:	*10.2	↗
30:	*10.8	←
Serie		95.0
Total		290.0

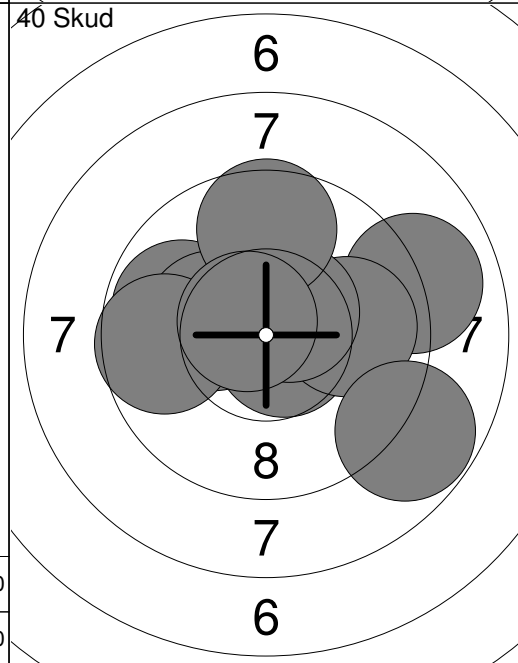

31:	*10.7	↘
32:	9.0	→
33:	9.9	→
34:	9.8	←
35:	*10.3	←
36:	9.6	←
37:	*10.5	↗
38:	9.6	↗
39:	*10.7	↙
40:	8.8	↘
Serie		93.0
Total		383.0

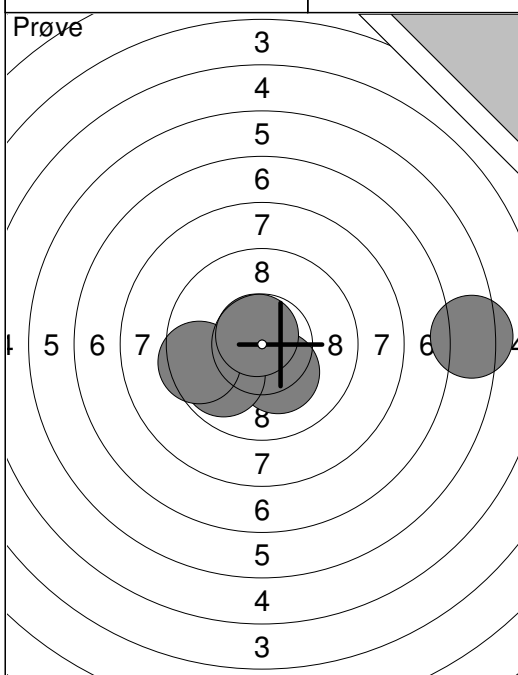

1: *10.2	↘
2: 9.9	↙
3: 6.4	→
4: 9.5	↙
5: *10.7	↗
Serie 44.0	
Total 0.0	

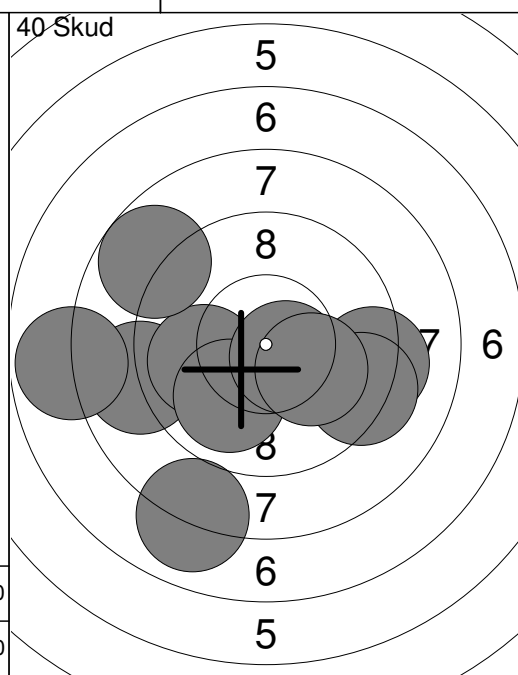

1: 8.0	↘
2: 8.9	↙
3: 9.9	↙
4: 10.0	↘
5: 9.2	→
6: 9.3	↘
7: *10.6	↘
8: 7.9	↙
9: 10.1	↘
10: 8.7	↗
Serie 88.0	
Total 88.0	

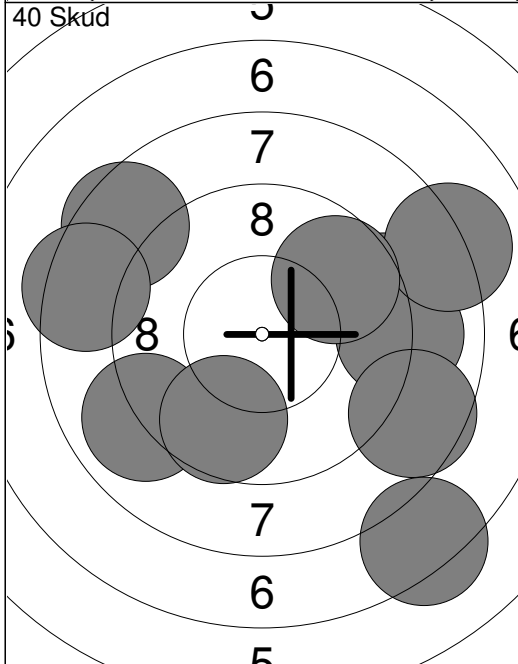

11: 9.2	→
12: 9.0	→
13: 8.1	→
14: 9.0	↙
15: 8.6	↘
16: 7.3	↘
17: 8.5	↗
18: 8.4	↙
19: 9.6	↘
20: 9.7	↗
Serie 84.0	
Total 172.0	

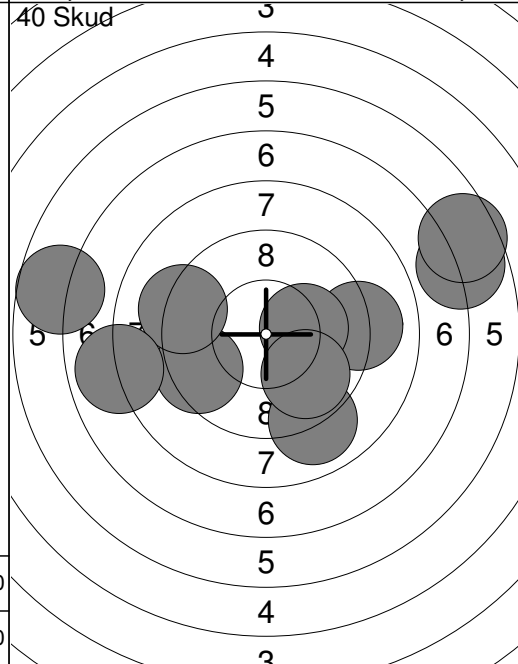

21: 9.1	→
22: 9.0	↘
23: *10.2	→
24: 9.4	↙
25: 6.8	→
26: 9.2	↙
27: 6.5	↗
28: 7.9	↙
29: 9.8	↘
30: 6.7	↙
Serie 80.0	
Total 252.0	

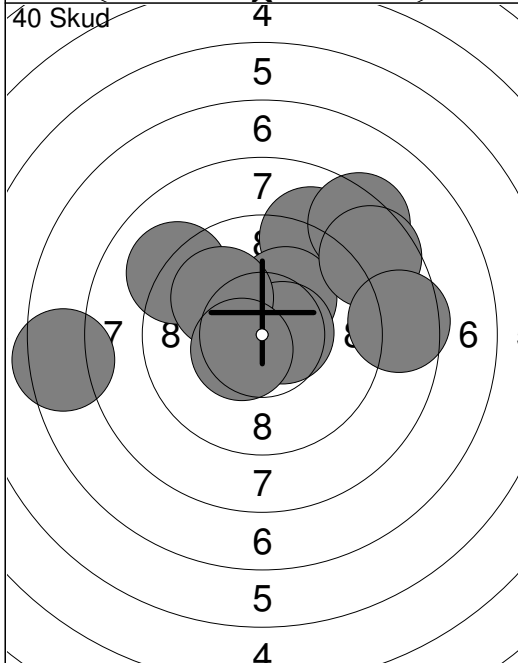

31: 9.1	↗
32: 7.5	↙
33: 8.4	↗
34: *10.2	↗
35: 8.6	↗
36: *10.6	→
37: 9.1	↙
38: 8.5	→
39: 10.0	↙
40: *10.5	↙
Serie 89.0	
Total 341.0	